

Shut-off damper

DSU



Description

Has a turning, circular blade. The blade is stepless adjustable 0–90°. The damper is used when you have lower demands for shut-off capacity. The damper admits an insulation thickness of approx. 50 mm.

The damper can on occasions be used for regulation.

Setting angle α

$\alpha = 0^\circ =$ open blade, $\alpha = 90^\circ =$ closed blade

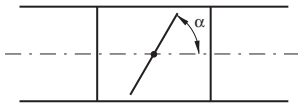

There is a separate assembly, measuring, balancing and maintenance instruction for this product.

Ø 63–1000 fullfills pressure class A in closed position.

The cup at Ø 63–630 can be complemented with the special insulation cup IK at insulation thicker than 50 mm.

Reinforced blade



Ordering example



Dimensions

Ø 63–630

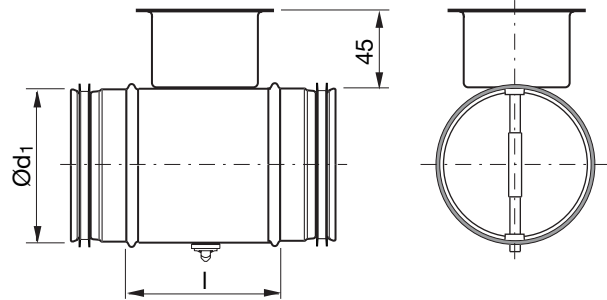

Ø 800–1000

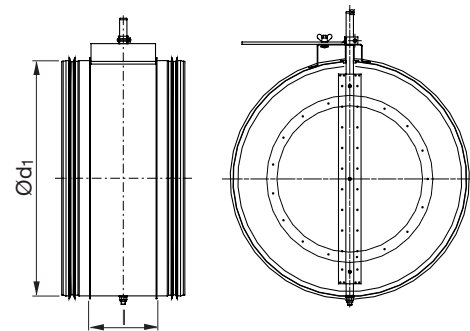

Ød ₁ nom	l [mm]	m [kg]	Sealing class past closed blade
63	100	0,30	0
80	100	0,35	0
100	100	0,40	0
112	100	0,44	0
125	100	0,49	0
140	100	0,54	0
150	100	0,57	0
160	100	0,67	0
180	100	0,73	0
200	100	0,86	0
224	100	1,10	0
250	100	1,31	0
280	100	1,51	0
300	100	1,65	0
315	100	1,81	0
355	100	2,00	0
400	100	2,91	1
450	100	3,90	1
500	115	4,92	1
560	115	6,01	1
600	115	6,40	1
630	115	6,92	1
800	230	19,0	1
1000	230	30,0	1



Shut-off damper

DSU

- 1
- 2
- 3
- 4
- 5
- 6
- 7
- 8
- 9
- 10
- 11
- 12
- 13
- 14
- 15
- 16
- 17
- 18

Property	Ø 63-315	Ø 400	Ø 500	Ø 630	Ø 800-1000
The blade is set via a knob in a protective cup.	x	x	x	x	
The setting of the blade is read against an embossed scale at the rim of the cup.	x	x	x	x	
The blade is locked with two screws, type Pozidriv (PZD2).	x	x	x	x	
The blade has reinforced locking with a sturdy wing nut.					x
The blade is reinforced.		x	x	x	
The blade is additionally reinforced.					x
With sturdy handle.		x	x	x	
With additionally reinforced handle.					x
With reinforced stop beads.			x	x	
The axle is reinforced.					x
The damper can be delivered prepared for motor.	x	x	x	x	
The damper can be delivered with motor.	x	x	x	x	x

Technical data

Pressure drop graphs with noise data for dimensioning

The solid curves show the pressure drop, Δp_t , over the damper as a function of flow q , and setting angle α .

The dashed curves give the A-weighted sound power data, L_{WA} , in dB to the duct.

Example

Given Dimension Ø100
 Flow 60 l/s
 Pressure drop 200 Pa
 Obtained from graph
 Setting angle 38°
 Sound power level 63 dB (A)

Ø80

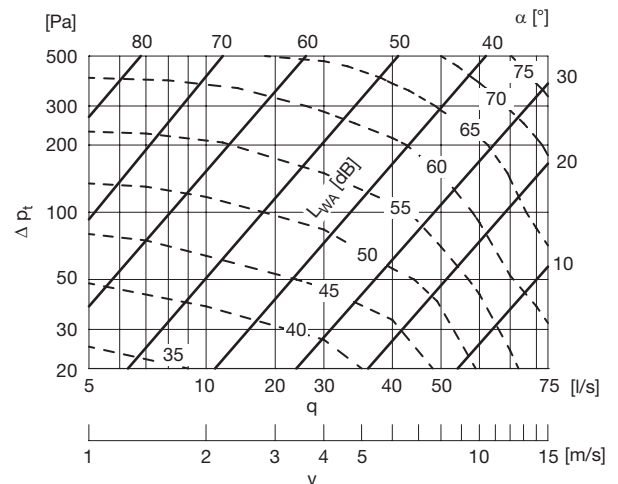

Ø100

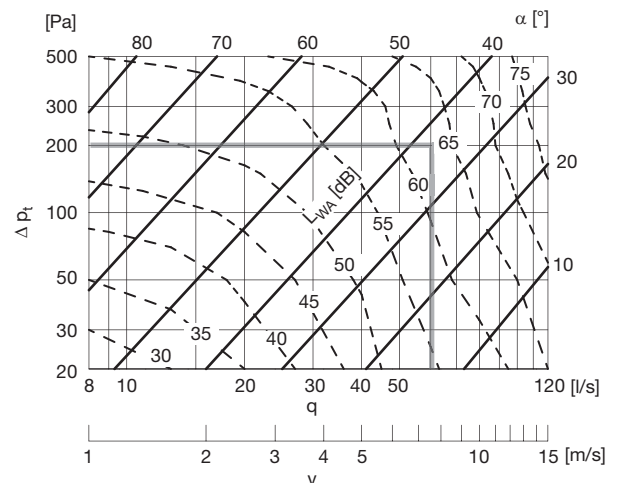

Shut-off damper

DSU

Ø112

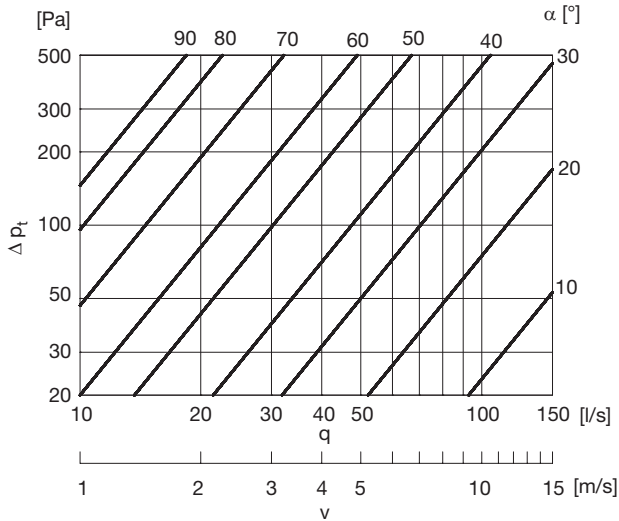

Ø150

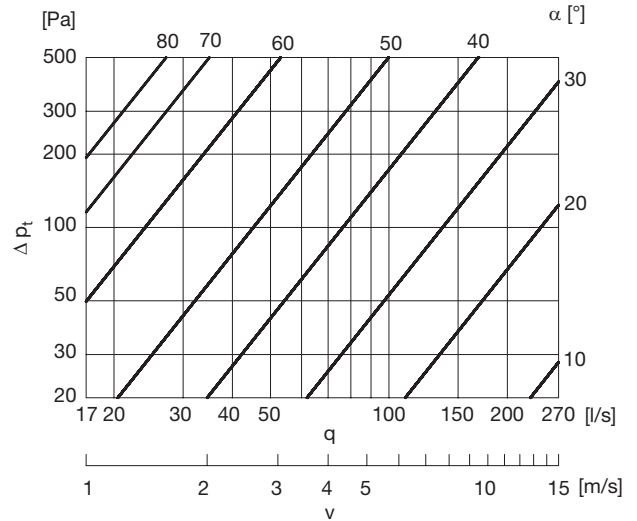

Ø125

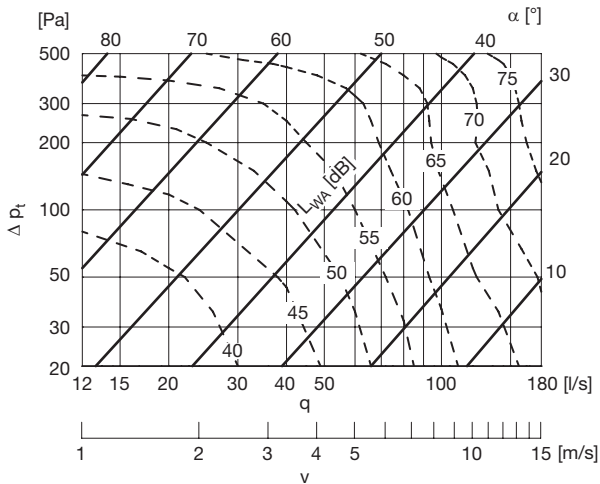

Ø160

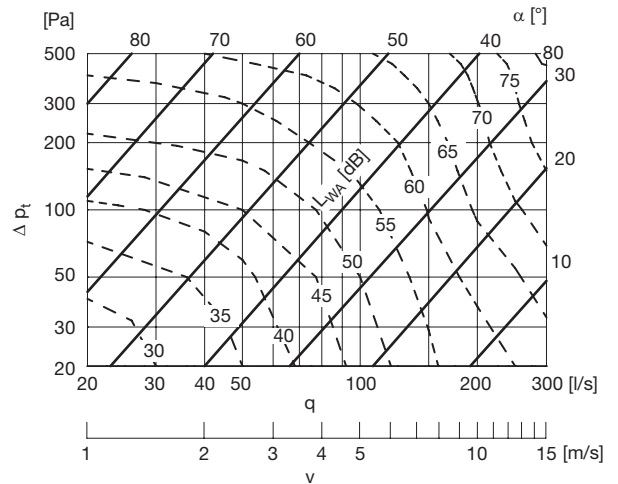

Ø140

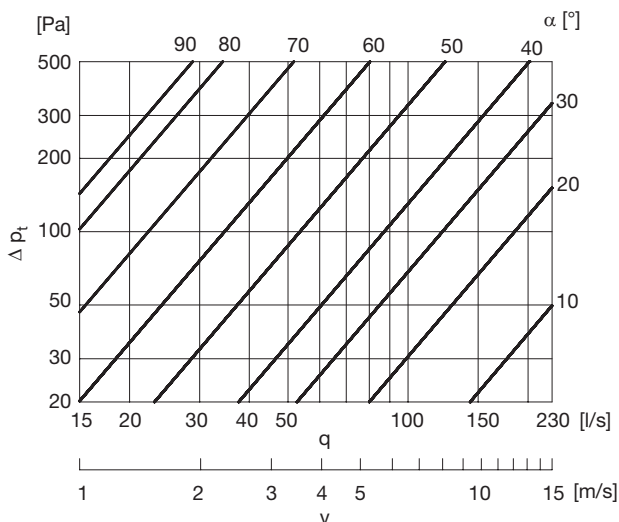

Ø180

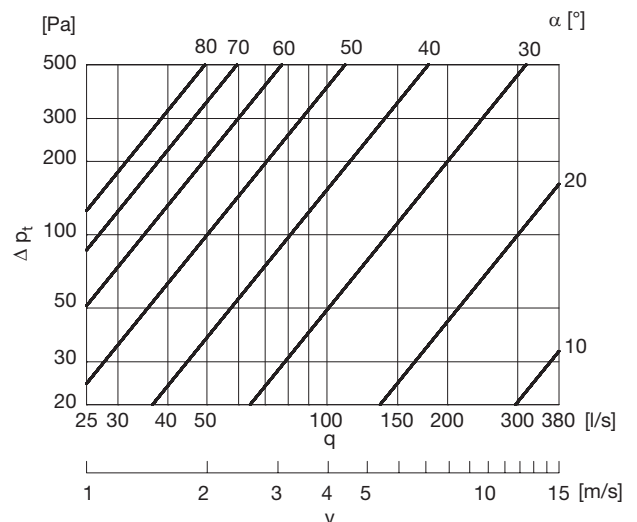

- 1
- 2
- 3
- 4
- 5
- 6
- 7
- 8
- 9
- 10
- 11
- 12
- 13
- 14
- 15
- 16
- 17
- 18

Shut-off damper

DSU

- 1
- 2
- 3
- 4
- 5
- 6
- 7
- 8
- 9
- 10
- 11
- 12
- 13
- 14
- 15
- 16
- 17
- 18

Ø200

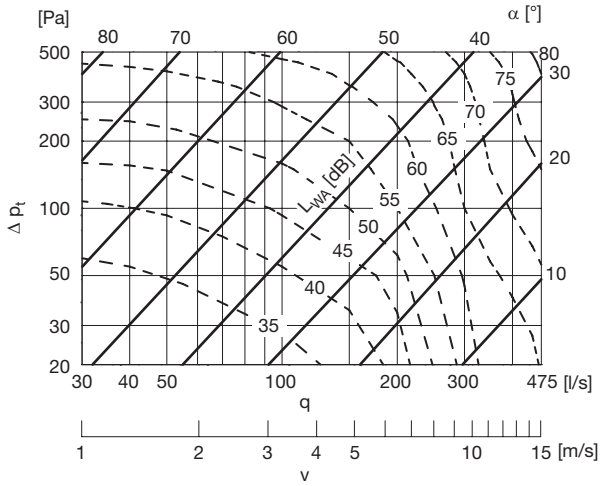

Ø280

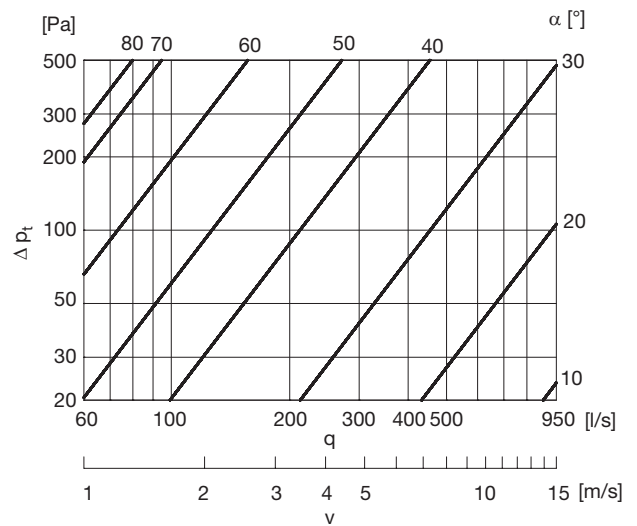

Ø224

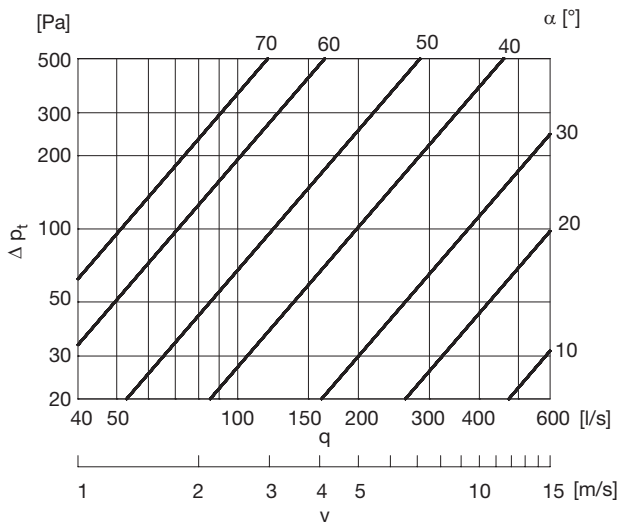

Ø300

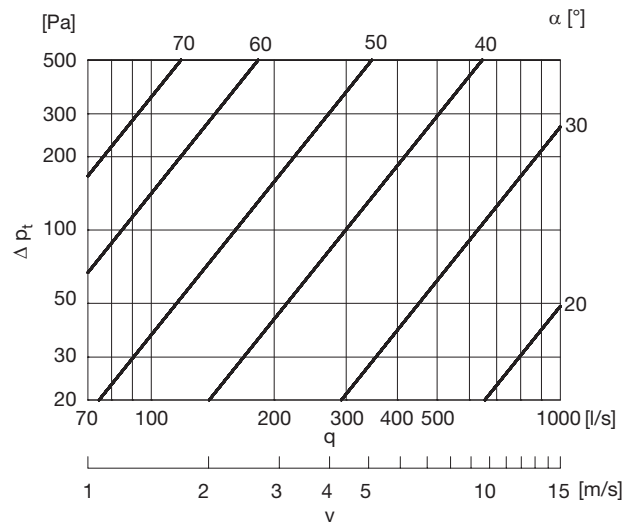

Ø250

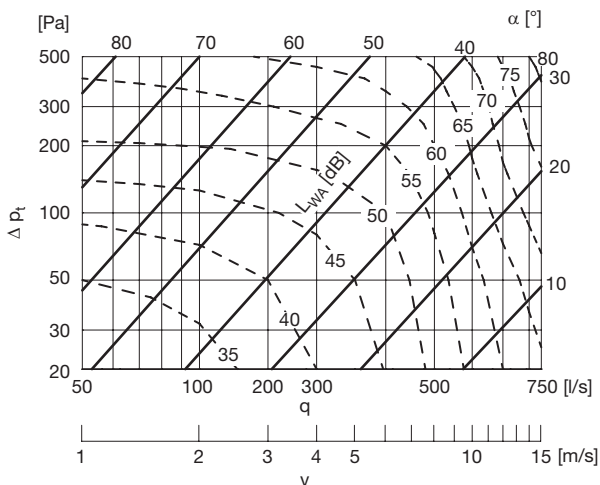

Ø315

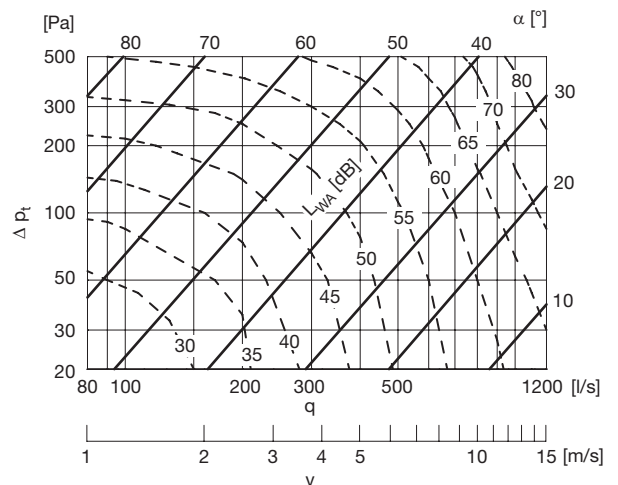

Shut-off damper

DSU

Ø355

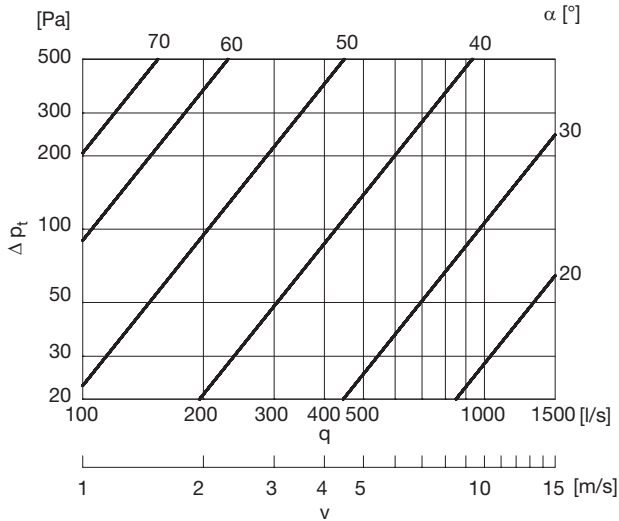

Ø500

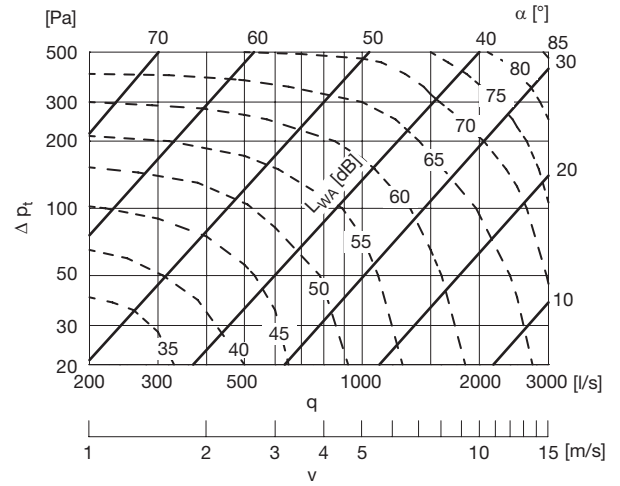

Ø400

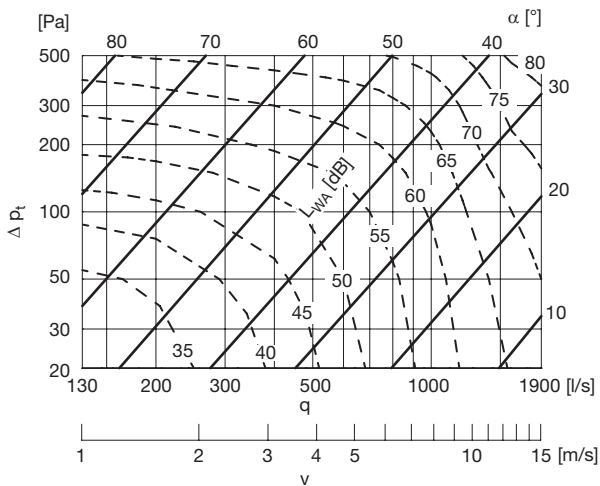

Ø560

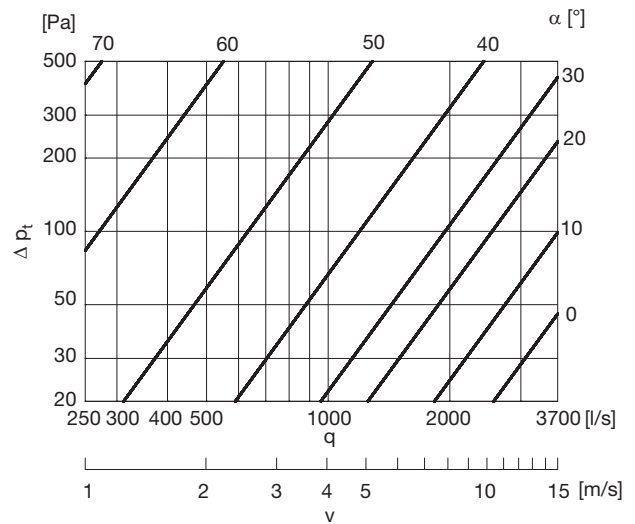

Ø450

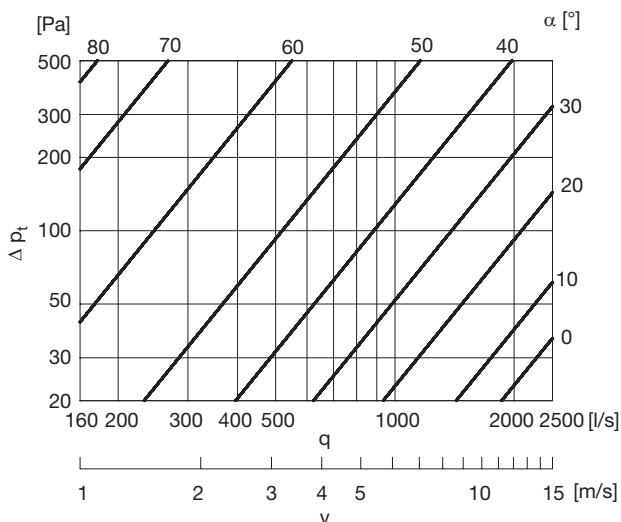

Ø600

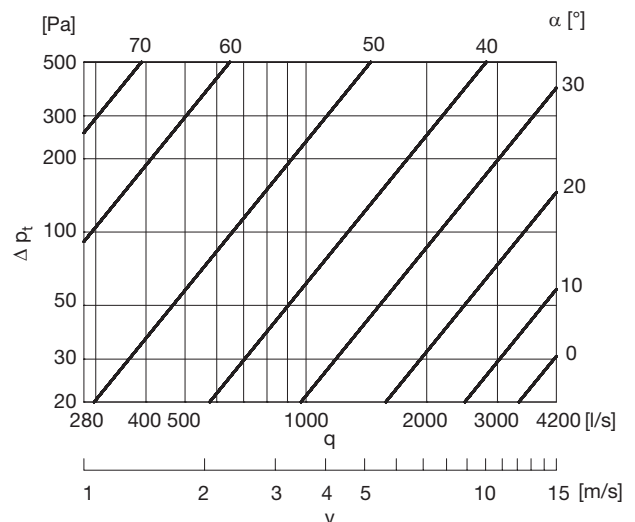

- 1
- 2
- 3
- 4
- 5
- 6
- 7
- 8
- 9
- 10
- 11
- 12
- 13
- 14
- 15
- 16
- 17
- 18

Shut-off damper

DSU

- 1
- 2
- 3
- 4
- 5
- 6
- 7
- 8
- 9
- 10
- 11
- 12
- 13
- 14
- 15
- 16
- 17
- 18

Ø630

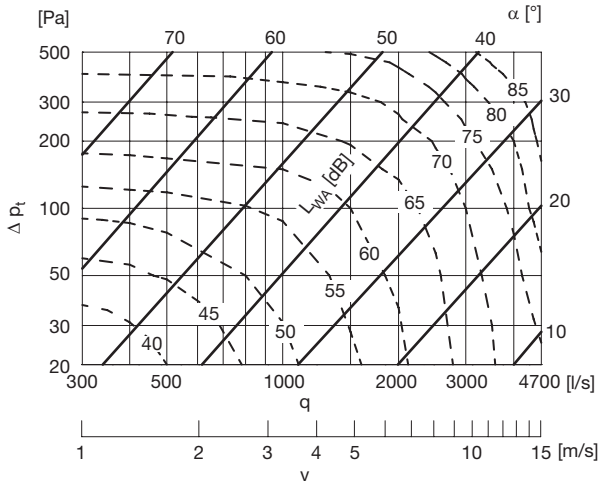

Ø900

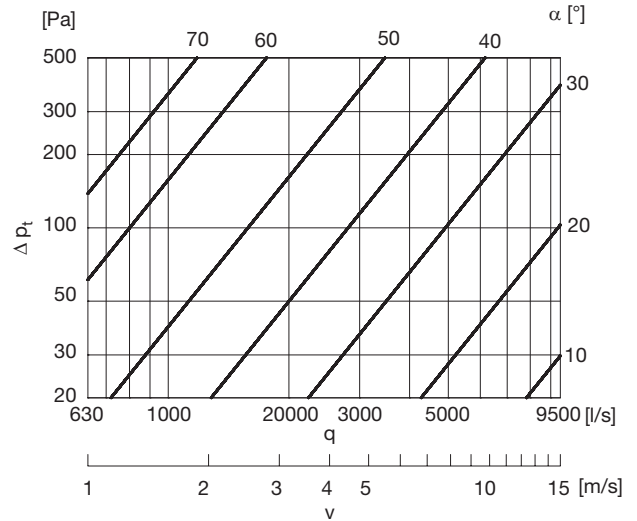

Ø710

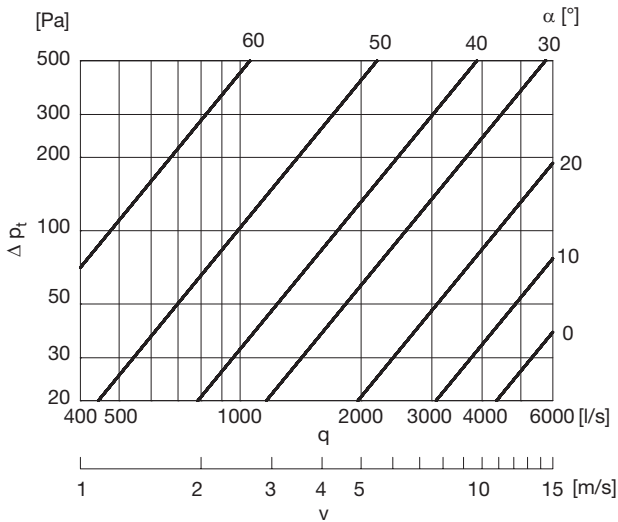

Ø1000

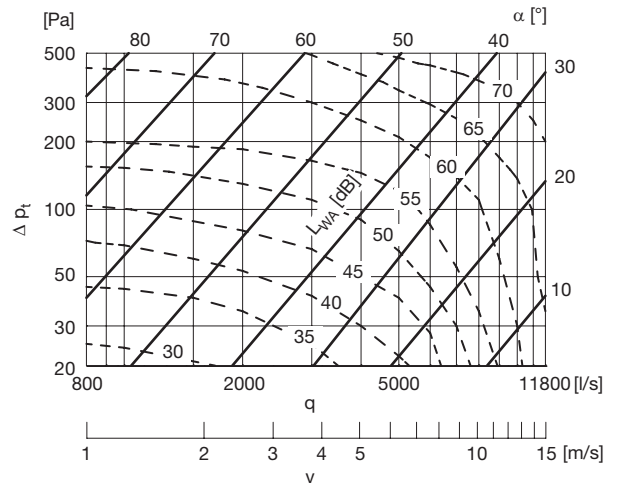

Ø800

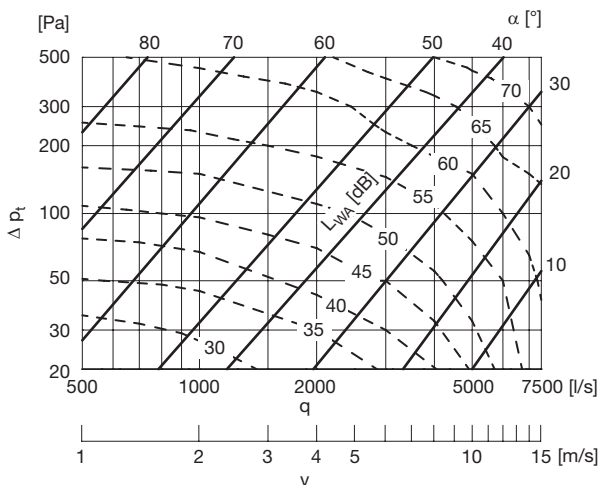

Shut-off damper

DSU

Sound data

Sound power level L_{W} , [dB] to duct in the octave bands 1–8, 63–8000 Hz, as a function of dimension, flow and pressure drop.

dim $\varnothing d_1$	Pressure loss [Pa]	Velocity app. 1 [m/s]						Velocity app. 3 [m/s]						Velocity app. 6 [m/s]											
		Centre frequency [Hz]						Centre frequency [Hz]						Centre frequency [Hz]											
		63	125	250	500	1k	2k	4k	8k	63	125	250	500	1k	2k	4k	8k	63	125	250	500	1k	2k	4k	8k
80		Flow 5 [l/s]						Flow 15 [l/s]						Flow 30 [l/s]											
	500	63	63	64	63	58	53	48	45	65	65	65	65	59	55	49	46	67	67	67	67	60	57	50	47
	200	61	61	58	52	49	42	33	28	63	63	60	54	51	43	34	29	65	65	62	56	53	44	35	30
	100	59	56	50	45	41	28	22	14	60	60	53	48	43	30	23	15	61	64	57	51	46	32	24	16
	50	53	49	43	40	33	23	15	8	56	54	47	43	36	25	16	9	59	59	52	47	40	27	17	10
20	47	42	36	32	25	16	7	1	51	47	39	35	28	18	8	2	54	52	44	39	32	20	9	4	
100		Flow 8 [l/s]						Flow 25 [l/s]						Flow 50 [l/s]											
	500	60	60	59	52	50	44	44	44	67	64	64	57	54	48	48	48	72	69	69	62	59	52	52	52
	200	53	51	53	43	42	35	32	32	59	58	58	50	48	40	37	37	66	65	64	57	54	45	42	42
	100	51	46	44	38	35	28	21	20	58	55	53	46	41	34	26	24	65	64	62	54	48	40	31	29
	50	48	42	38	33	26	19	16	14	55	53	48	42	35	26	22	18	64	63	60	53	44	33	28	22
20	43	35	30	23	17	9	7	6	50	49	42	37	28	17	15	14	62	61	57	51	41	27	25	15	
125		Flow 12 [l/s]						Flow 40 [l/s]						Flow 75 [l/s]											
	500	66	63	61	55	52	46	47	44	71	68	65	59	56	50	50	47	76	73	70	63	60	53	53	50
	200	59	53	49	44	38	34	33	32	65	62	57	51	46	41	38	38	72	71	65	59	53	47	43	43
	100	58	49	43	40	31	28	22	22	64	59	53	47	39	34	29	27	71	70	63	55	47	40	35	32
	50	57	42	41	31	29	20	17	15	63	54	50	41	36	27	25	20	70	68	60	51	43	34	32	24
20	56	32	39	29	27	11	15	11	62	48	48	34	34	20	22	15	68	65	56	47	39	29	28	17	
160		Flow 20 [l/s]						Flow 60 [l/s]						Flow 120 [l/s]											
	500	62	63	61	56	52	51	50	49	68	67	64	59	55	53	52	51	73	71	68	62	59	55	54	53
	200	52	52	51	44	43	38	37	36	61	58	56	50	48	42	40	40	71	65	62	56	53	47	44	44
	100	47	43	39	37	32	27	27	25	59	54	50	45	40	35	33	31	70	64	60	53	48	42	39	38
	50	42	36	33	28	25	20	17	16	54	50	46	37	33	29	25	25	69	63	58	48	42	37	32	32
20	37	30	30	26	19	16	11	10	49	46	43	35	27	24	19	18	68	61	55	44	36	32	27	23	
200		Flow 30 [l/s]						Flow 100 [l/s]						Flow 200 [l/s]											
	500	65	60	56	52	49	47	44	42	70	64	61	55	52	52	55	55	75	69	65	59	55	55	59	59
	200	55	52	51	43	40	37	38	38	62	57	55	47	44	42	42	42	71	65	61	53	50	48	47	47
	100	46	43	41	34	32	29	29	29	57	52	48	41	39	36	34	34	69	64	58	50	47	44	42	42
	50	40	38	33	30	28	27	23	22	51	45	41	36	32	32	28	28	63	56	51	44	39	39	34	34
20	34	31	26	25	25	23	18	16	44	37	33	29	27	25	21	19	56	47	43	36	29	27	24	22	
250		Flow 50 [l/s]						Flow 150 [l/s]						Flow 300 [l/s]											
	500	67	65	57	50	47	52	51	50	69	66	59	53	50	54	53	52	71	67	61	56	53	56	55	54
	200	55	54	49	43	42	38	42	42	59	57	52	46	44	41	44	44	63	60	55	49	46	44	46	46
	100	52	48	40	37	34	33	31	28	56	52	45	41	38	36	34	31	62	57	51	46	43	40	38	35
	50	44	41	35	32	29	24	22	20	52	48	40	38	34	30	28	24	61	56	47	45	40	38	33	28
20	33	35	29	29	25	15	12	10	47	44	37	35	31	25	22	17	59	54	46	42	38	36	30	24	
315		Flow 80 [l/s]						Flow 250 [l/s]						Flow 500 [l/s]											
	500	63	60	53	49	47	46	45	44	68	65	59	53	50	50	53	50	74	71	65	58	55	55	58	55
	200	50	44	42	38	38	33	37	34	60	55	50	45	43	40	43	40	70	65	58	52	49	48	49	46
	100	42	39	33	31	30	25	30	23	54	52	45	41	38	36	36	31	66	64	56	50	47	46	44	39
	50	34	34	30	26	22	21	19	15	49	49	43	38	34	32	30	24	64	63	55	49	45	42	40	32
20	26	30	27	21	16	15	13	11	44	46	41	35	30	27	25	18	62	61	54	48	43	37	34	24	
400		Flow 130 [l/s]						Flow 400 [l/s]						Flow 800 [l/s]											
	500	76	71	66	59	55	58	57	56	79	73	67	62	57	60	59	58	82	75	68	65	59	62	61	60
	200	61	58	50	44	43	44	45	41	67	62	56	50	48	48	48	45	74	68	62	56	53	52	52	49
	100	50	45	40	34	36	35	35	29	61	56	49	44	42	39	39	34	72	67	58	53	49	47	46	40
	50	42	37	31	29	28	27	25	20	57	52	44	39	37	35	34	26	71	66	56	50	47	44	44	33
20	40	34	27	25	24	23	21	11	55	50	40	35	34	32	30	20	70	65	54	47	44	40	38	28	
500		Flow 200 [l/s]						Flow 600 [l/s]						Flow 1200 [l/s]											
	500	82	76	69	63	62	61	60	59	84	77	70	64	63	62	61	60	85	78	71	65	64	63	62	61
	200	66	60	55	48	45	44	46	43	71	65	59	53	50	50	47	77	70	64	58	56	55	54	51	
	100	55	50	47	38	38	36	34	31	63	58	53	47	46	44	42	37	72	66	60	55	53	51	49	43
	50	46	40	36	33	32	29	29	25	59	52	47	44	42	38	38	31	71	63	57	54	51	46	46	37
20	41	33	29	27	26	19	18	20	56	47	42	40	38	32	30	26	70	60	54	52	49	44	40	32	
630		Flow 300 [l/s]						Flow 900 [l/s]						Flow 1800 [l/s]											
	500	86	77	71	67	64	61	61	60	88	80	73	69	66	64	63	62	90	83	75	71	68	67	65	64
	200	76	70	63	60	56	53	52	48	78	72	65	62	59	55	55	49	80	74	67	64	60	57	57	50
	100	65	61	52	49	45	43	41	37	71	66	59	54	50	46	45	40	78	71	66	59	56	49	48	44
	50	54	49	45	39	34	36	30	26	66	58	53	48	43	40	39	30	77	68	62	57	51	45	47	36
20	45	35	38	30	29	29	26	20	61	50	47	43	38	36	33	25	76	65	57	55	46	42	39	30	
800		Flow 500 [l/s]						Flow 1500 [l/s]						Flow 3000 [l/s]											
	500	56	53	54	51	52	52	47	44	64	59	58	57	57	56	54	50	72	65	62	63	62	62	61	56
	200	49	43	41	43	47	46	41	31	58	52	49	49	50	49	45	37	67	60	56	55	53	52	49	43
	100	46	40	39	39	41	36	30	23	55	48	45	44	44	40	35	29	63	55	51	49	47	44	40	34
	50	44	37	34	32	29	25	19	15	52	44	40	38	35	31	26	20	60	50	46	44	41	37	33	25
20	31	33	27	22	21	11	12	1	44	36	32	28	25	17	13	2	56	40	37	34	29	23	14	9	
1000		Flow 800 [l/s]						Flow 2400 [l/s]						Flow 4750 [l/s]											
	500	59	53	50	50	53	50	49	68	62	58	58	57	57	56	53	77	70	66	67	64	64	63	57	
	200	55	47	48	47	47	50	46	34	64	56	53	52	52	51	48	38	72	64	58	56	54	52	50	42
	100	52	46	39	42	41	38	34	24	60	52	46	45	44	41	37	28	67	58	53	49	47	44	40	32
	50	50	40	32	34	31	26	21	10	56															

Shut-off damper

DSU

dim Ød ₁	Pressure loss [Pa]	Velocity app. 9 [m/s]								Velocity app. 12 [m/s]								Velocity app. 15 [m/s]							
		Centre frequency [Hz]								Centre frequency [Hz]								Centre frequency [Hz]							
		63	125	250	500	1k	2k	4k	8k	63	125	250	500	1k	2k	4k	8k	63	125	250	500	1k	2k	4k	8k
80		Flow 45 [l/s]								Flow 60 [l/s]								Flow 75 [l/s]							
	500	72	70	70	70	63	60	53	49	77	76	75	75	68	64	56	53	80	80	80	80	72	68	60	56
	200	70	68	67	60	57	48	38	32	75	74	71	65	61	51	41	34	78	77	72	70	64	53	42	35
	100	66	65	63	57	51	36	27	18	74	73	70	60	57	45	32	25	77	75	71	65	58	46	33	26
	50	63	62	58	52	45	28	18	11	73	71	66	55	52	40	25	19	75	72	67	58	53	41	26	20
	20	59	58	51	46	38	21	10	5	70	67	60	47	44	32	17	13	72	68	62	50	47	36	20	15
100		Flow 75 [l/s]								Flow 100 [l/s]								Flow 120 [l/s]							
	500	78	75	75	67	64	57	57	57	84	81	80	72	68	62	61	61	88	86	85	76	72	65	64	64
	200	74	73	72	64	59	50	47	46	80	79	78	69	66	55	51	51	84	83	81	72	68	59	55	54
	100	73	72	71	62	56	46	36	33	79	78	75	65	60	49	44	42	82	81	78	69	63	54	48	45
	50	72	70	68	58	51	40	29	23	77	76	70	60	53	43	36	31	80	79	74	65	57	48	40	35
	20	70	67	63	53	44	33	26	17	74	73	65	54	46	37	27	20	78	77	69	60	50	41	31	24
125		Flow 110 [l/s]								Flow 145 [l/s]								Flow 180 [l/s]							
	500	83	80	76	68	65	58	58	54	89	87	81	73	69	62	62	58	91	88	83	75	71	63	63	59
	200	79	78	71	65	58	51	48	47	87	85	78	70	63	56	52	48	88	86	80	71	66	59	54	49
	100	78	77	70	61	51	45	39	35	86	83	75	66	58	50	44	39	87	84	78	69	61	53	47	42
	50	77	76	68	57	45	39	33	25	84	80	71	61	52	44	36	28	86	82	75	65	55	47	39	33
	20	76	75	64	53	40	33	30	18	81	76	66	55	45	38	32	19	85	81	71	60	48	41	34	22
160		Flow 180 [l/s]								Flow 240 [l/s]								Flow 300 [l/s]							
	500	78	77	74	67	63	60	59	58	84	84	80	72	68	65	65	65	89	89	85	77	73	69	69	69
	200	76	73	70	63	59	53	50	50	80	80	77	69	66	58	55	55	85	84	80	73	70	64	59	58
	100	75	72	69	61	54	48	45	44	78	76	73	66	61	53	50	48	83	80	77	70	65	58	54	52
	50	74	71	66	58	49	40	38	33	76	72	68	62	55	47	43	38	80	76	72	66	59	51	47	42
	20	73	66	61	54	43	35	30	25	74	68	63	57	48	40	35	27	76	71	65	61	52	43	39	30
200		Flow 300 [l/s]								Flow 400 [l/s]								Flow 475 [l/s]							
	500	85	79	72	65	62	61	65	65	92	85	79	72	68	66	71	70	95	89	82	73	71	70	74	73
	200	83	77	70	62	58	55	54	54	90	83	77	69	65	62	61	60	92	85	79	71	66	64	64	63
	100	82	76	69	59	56	53	50	50	88	80	73	65	61	58	55	53	90	83	76	68	63	61	58	56
	50	81	74	65	56	52	49	45	42	85	76	68	60	56	52	48	45	88	80	72	64	59	56	52	48
	20	80	70	60	52	46	43	38	32	81	72	62	54	50	45	40	36	86	76	67	59	54	50	47	39
250		Flow 450 [l/s]								Flow 600 [l/s]								Flow 750 [l/s]							
	500	78	75	68	61	58	61	60	59	87	83	76	68	68	68	68	68	94	90	82	74	71	74	74	74
	200	74	69	63	57	55	54	54	53	82	79	72	64	63	63	62	61	88	84	77	69	68	67	68	65
	100	72	68	60	56	52	49	45	42	79	76	69	62	60	60	58	57	85	81	74	67	65	63	62	59
	50	69	67	58	54	48	44	37	32	76	72	65	59	56	54	51	48	82	78	70	64	61	58	55	52
	20	66	65	56	52	44	39	32	27	73	68	61	56	51	46	42	38	79	75	65	60	56	53	47	46
315		Flow 750 [l/s]								Flow 1000 [l/s]								Flow 1200 [l/s]							
	500	82	78	71	64	60	60	60	60	89	85	77	69	68	67	69	65	92	88	80	72	71	70	72	68
	200	77	72	66	59	58	57	56	52	86	79	72	65	63	62	63	58	88	83	75	68	66	65	64	59
	100	76	71	64	57	54	52	50	44	84	77	69	62	60	58	57	53	87	80	72	65	63	61	59	55
	50	75	70	61	54	50	46	43	35	82	74	66	59	55	52	49	46	85	77	69	62	59	55	52	48
	20	74	68	58	51	46	39	36	26	80	71	63	56	48	44	39	38	82	74	66	60	54	47	46	40
400		Flow 1200 [l/s]								Flow 1500 [l/s]								Flow 1900 [l/s]							
	500	88	81	74	70	63	66	65	64	95	87	79	75	69	71	70	69	98	90	82	78	73	74	73	72
	200	83	76	68	61	60	59	58	54	89	82	75	69	67	64	63	60	92	84	77	70	69	67	65	63
	100	82	75	67	60	58	55	53	47	86	80	72	66	63	61	58	55	89	82	74	68	66	64	61	58
	50	80	73	65	58	56	51	47	39	83	77	68	63	58	56	52	48	86	80	71	66	62	59	55	51
	20	77	70	63	55	53	47	42	30	80	74	64	60	54	50	45	40	83	78	68	64	58	51	47	42
500		Flow 1800 [l/s]								Flow 2400 [l/s]								Flow 3000 [l/s]							
	500	91	84	76	68	67	68	68	67	96	88	80	72	70	73	72	71	102	94	85	78	75	77	77	76
	200	85	78	72	65	63	61	60	57	91	84	76	70	66	66	65	61	96	89	80	72	68	68	68	67
	100	82	74	69	62	59	57	55	50	88	75	70	63	60	58	56	52	93	85	76	69	65	63	61	58
	50	79	71	66	59	55	52	48	43	85	72	67	60	56	53	49	44	90	80	72	65	62	57	53	49
	20	76	67	63	56	50	47	41	36	82	69	64	57	52	48	43	37	87	75	67	61	58	54	46	40
630		Flow 2800 [l/s]								Flow 3700 [l/s]								Flow 4700 [l/s]							
	500	96	88	80	76	72	72	70	68	103	95	86	82	77	77	76	73	107	98	90	85	81	81	80	76
	200	90	83	76	71	67	63	63	56	98	90	82	78	74	70	70	62	103	95	87	82	78	76	73	66
	100	89	82	75	68	63	58	55	50	95	88	79	74	70	65	63	57	100	92	84	79	75	71	67	62
	50	87	80	72	65	58	52	48	42	92	84	75	69	65	60	56	51	97	89	80	74	70	65	60	56
	20	84	77	68	61	52	45	42	33	89	82	70	63	59	55	49	43	94	86	75	68	64	58	52	48
800		Flow 4500 [l/s]								Flow 6000 [l/s]								Flow 7500 [l/s]							
	500	78	70	66	66	65	64	63	58	83	73	69	69	68	66	65	60	84	75	71	70	69	67	66	61
	200	72	64	60	59	57	55	52	46	77	67	63	62	60	58	55	49	80	70	66	65	63	61	58	52
	100	68	59	55	53	51	48	44	37	73	63	59	57	55	52	48	42	77	67	62	60	57	55	51	45
	50	66	55	51	48	45	42	37	30	71	60	55	52	49	47	41	35	76	65	61	58	54	52	47	40
	20	61	46	43	39	35	32	25	18	69	58	53	50	47	41	37	29	74	63	59	56	52	48	43	36
1000		Flow 7100 [l/s]								Flow 9450 [l/s]								Flow 11800 [l/s]							
	500	81	74	69	69	67	65	64	58	85	77	71	70	68	67	65	60	86	79	72	71	69	68	66	61
	200	76	69	63	60	57	55	53	45	80	71	65	64	61	58	57	50	83	74	68	67	64	61	60	55
	100	72	64	58	55	52	49	47	39	76	67	61	59	56	54	52	46	80	72	65	63	60	59	57	53
	50	68	60	54	52	48																			